

LINK & LOCK SCREENS & ENCLOSURES

TYPICAL ISOMETRICS

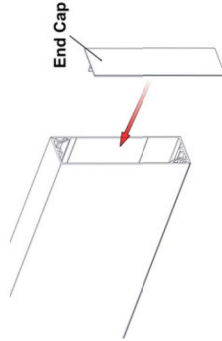

PROFILES

1-5/8" X 2", 4", 6", 8"
Standard lengths: 24'

COMPONENTS

End Caps, Mounting Clips.

ATTACHMENT

Fasten w. #12 screws* @ 6' o.c. using mounting clips. (*Not included)
△ See install guide for details.

TYPICAL SECTIONS

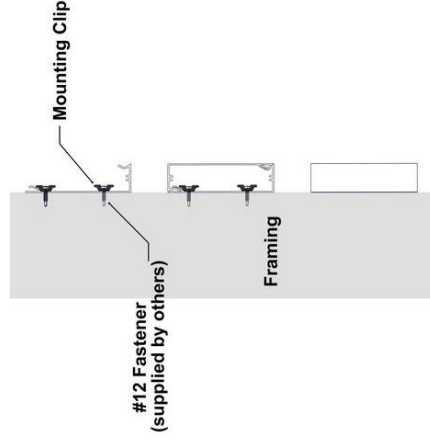

FINISHES

Woodgrains, solid colors, naturally aged metals, special order. Custom solid color matching available (additional lead times apply).

LEAD TIME

3-6 business days + shipping (subject to change).

BIM & CAD

RVT & DWG files available, see our website for details.

TECHNICAL SPECIFICATIONS

PHYSICAL DATA

6063-T5 Extruded Aluminum

100% Recyclable

Warranty: Finish:15 year (standard)/20 year* (Ultra) (*10 week lead time);

Aluminum: 50 year

Weight (lbs/lf): 0.93 (2"); 1.3 (4"); 1.5 (6"); 1.9 (8")

TESTING

ICC-ES Evaluation Report - Division: 05 00 00 - METALS

- Section: 05 50 00 - Metal Fabrications

LARR - Los Angeles Department of Building Safety (LADBS) accepts ICC-ES reports as proof of compliance

Florida Building Code - Building

Florida Building Code - Residential

WUI (The Wildland-Urban Interface) – California Department of Forestry & Fire Protection Office of the State Fire Marshal Listing No. 8140-2286:0500



Fire Rating: Class A Non-Combustible by ASTM E136 & ASTM E84



Light reflectance (LRV): Up to 73.2% (Ultra White)

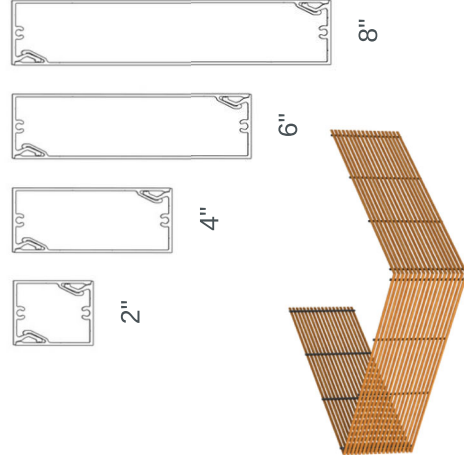

L3 LONGBOARD®
ARCHITECTURAL PRODUCTS

info@longboardproducts.com

longboardproducts.com

800 604 0343

Exterior

Link & Lock Screens & Enclosures

Installation Guidelines

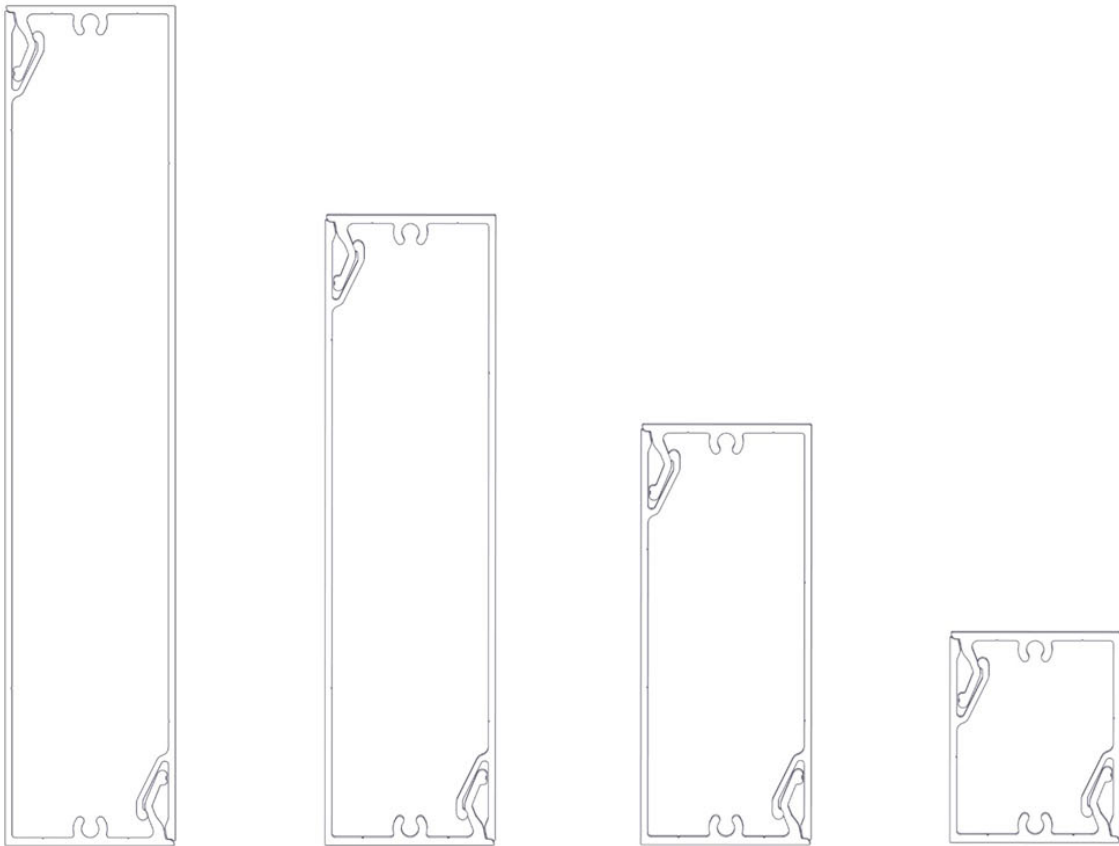

1.0. GENERAL

1.1. Product Description

Longboard® Link & Lock Privacy Screen is an extruded aluminum open joint privacy screen system, designed to be installed horizontally or vertically, as battens or fins/louvers. Available in standard lengths of 24' (7.3m) and widths of 4" (101.6mm), 6" (152.4mm) & 8" (203mm). End Caps with a matching finish are used to close off the ends. Longboard Link & Lock Privacy Screen can be installed directly to a post structure or outboard of a UV barrier or building envelope & wall finish.

1.2. Installation Considerations

Depth of system (measured from substrate to finished face):

Battens (flat on wall)= 1-5/8" (41.3mm)

Fins/Louvers (on edge) = 4" (101.6mm), 6" (152.4mm) or 8" (203.2mm)

(See Appendix to access profile drawings)

Longboard Products are not recommended for use on marine applications in direct contact with salt water.

1.3. Cutting

⚠ Always be sure to wear appropriate PPE: eye & hearing protection.

Use standard wood-cutting tools such as a miter saw with a carbide blade (60-80 tooth) for non-ferrous metals (aluminum).

Trim the taped/punched ends of all stock length material by 1/2" (12mm) each end and discard (see 1.5.).

1.4. Fastening

Longboard Link & Lock consists of two (2) matching L-shaped extrusions, snapped together to make a complete set. The back "L" is mechanically fastened to the substrate, using #12 (preferred) or #10 (min.) sharp-point (for wood substrates) or self-drilling (for metal substrates) zinc-plated or other corrosion resistant screws (not included) every 6' (1.83m) o.c. (max.).

Fastener types such as Pan Head, Hex Head or Truss Head are recommended.

⚠ All fasteners should be suitable for exterior use and be compatible with the substrate type.

Layout and predrill* the back "L" at all fastener locations: a single hole at or near the center length of each section & double drilled/slotted holes at each location either side of center.

Refer to the fastener installation guide diagram for hole dimensions and details.

**See table 1 & 2 to calculate the thermal movement for your project, to ensure adequate allowances have been made.*

Link & Lock - Fastener Installation Guide

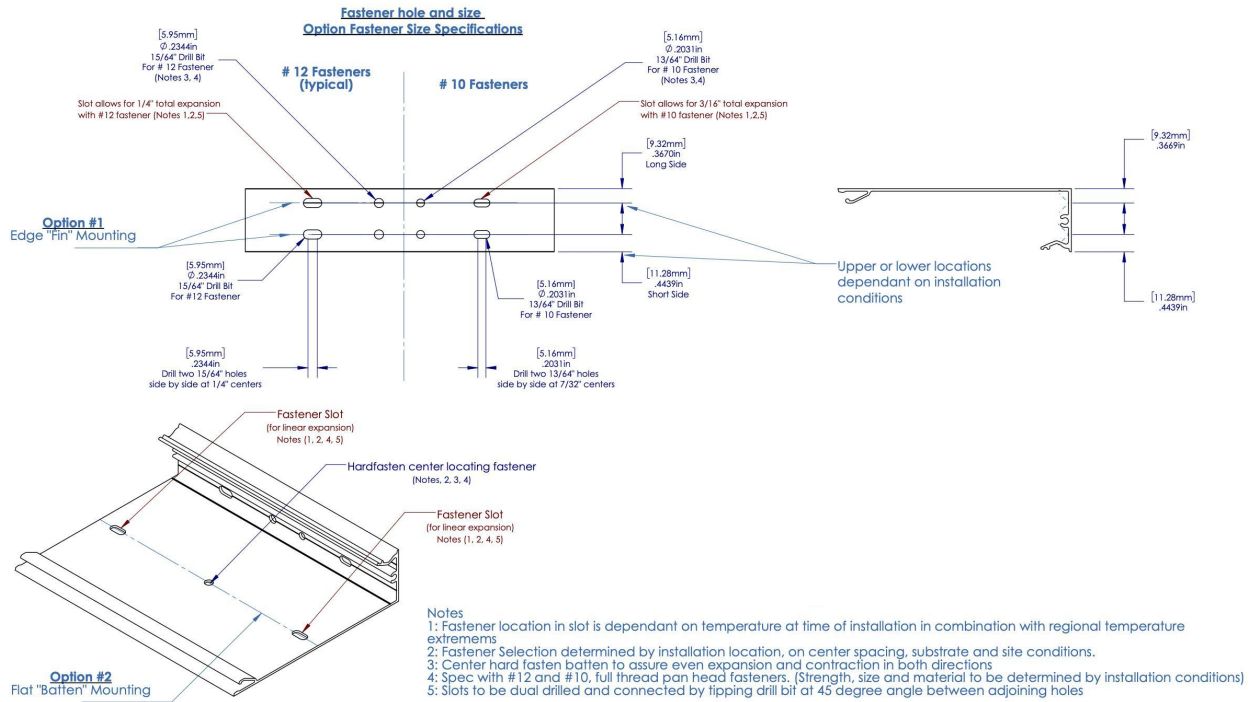

! Fasten the center location at the single drilled hole to prevent migration of the material over time. Fasten at the slotted locations to allow for expansion & contraction at each side of center. At the time of installation, consider the current temperature as it relates to the expected annual high and low range, to place the fasteners at the slotted holes at either the:

- + center of the slot (at average annual)
- + toward end of plank (colder than average annual)
- + toward center of plank (warmer than average annual)

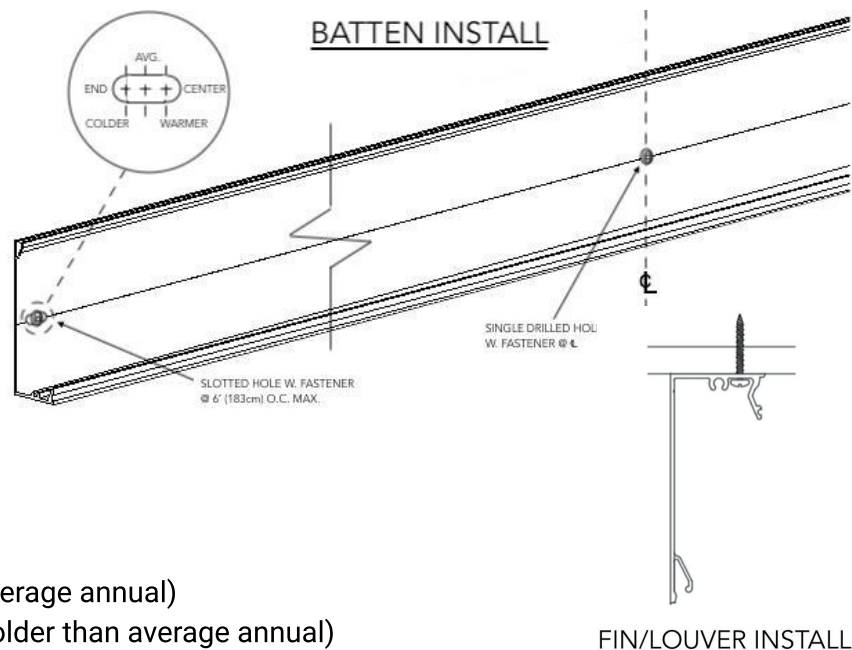

Example: winter typically experiences lows of -20°C (-4°F), summer typically experiences highs of +30°C (86°F) and it is +5°C (41°F) at the time of installation: Place fasteners at the center of the slotted holes.

Ensure all fasteners are anchored into solid-secure framing, blocking or furring strips. Snap the second “L” onto the first using a rubber mallet/hammer & block to protect the finish, then press end-caps in place at each end. Consider your application sequence of end caps before installing adjacent Link & Lock members, as they may limit the space needed to insert caps. All pieces are friction fit: If preferred, place a single small pea-sized spot of a structural grade silicone (not included) inside the connecting surface to prevent slippage (front “L”) or ease of removal (end caps).

1.4.1. Expansion & Contraction

In most climate zones, Link & Lock Privacy Screen will expand & contract 1/4” (6mm) over 24’ (7.3m) measured over a 30°C (54°F) temperature range*.

**See table 1 & 2 to calculate the thermal movement for your project.*

Fins/Louvers/Battens should be installed with staggered butt-joints, leaving a 1/4” (6mm)(min.) gap between the ends of each set, every 24’ (7.3m) or less (see Detail A). Alternatively, staggered lap-joints are an option for a continuous appearance (see Detail B) however 1/4” (6mm) gaps should be left at each joint to allow for thermal movement. Be sure to lap joints by 2’ (610mm) minimum over the back “L”.

See **3. System Installation** for layout details and table 1 & 2 for expansion & contraction calculations per foot/meter of material.

Detail A: BUTT-JOINTS

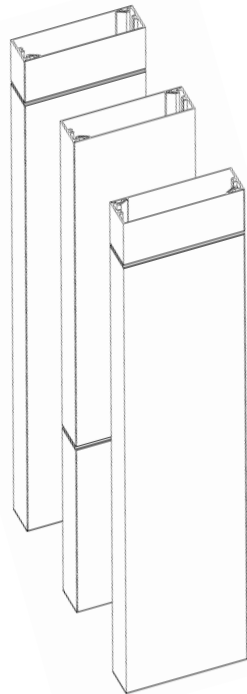

Detail B: LAP JOINTS

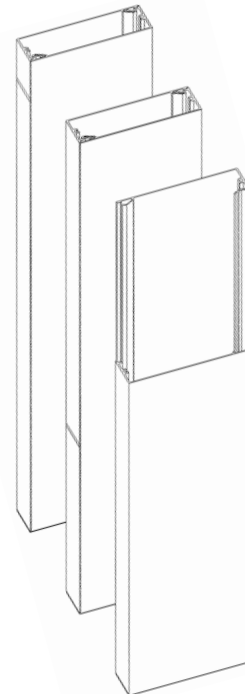

TABLE 1 & 2: MATERIAL THERMAL MOVEMENT RELATING TO AMBIENT TEMPERATURE

TABLE 1 - IMPERIAL

		AVERAGE TEMPERATURE AT TIME OF CUTTING & INSTALLATION											
°C		-50	-40	-30	-20	-10	0	10	20	30	40	50	
°F		-58	-40	-22	-4	14	32	50	68	86	104	122	
MIN/MAX POST CONSTRUCTION TEMP.	°C	°F	EXPANSION OR CONTRACTION (INCH/FOOT)										
	-50	-58	0.000	-0.003	-0.005	-0.008	-0.011	-0.014	-0.016	-0.019	-0.022	-0.024	-0.027
	-40	-40	0.003	0.000	-0.003	-0.005	-0.008	-0.011	-0.014	-0.016	-0.019	-0.022	-0.024
	-30	-22	0.005	0.003	0.000	-0.003	-0.005	-0.008	-0.011	-0.014	-0.016	-0.019	-0.022
	-20	-4	0.008	0.005	0.003	0.000	-0.003	-0.005	-0.008	-0.011	-0.014	-0.016	-0.019
	-10	14	0.011	0.008	0.005	0.003	0.000	-0.003	-0.005	-0.008	-0.011	-0.014	-0.016
	0	32	0.014	0.011	0.008	0.005	0.003	0.000	-0.003	-0.005	-0.008	-0.011	-0.014
	10	50	0.016	0.014	0.011	0.008	0.005	0.003	0.000	-0.003	-0.005	-0.008	-0.011
	20	68	0.019	0.016	0.014	0.011	0.008	0.005	0.003	0.000	-0.003	-0.005	-0.008
	30	86	0.022	0.019	0.016	0.014	0.011	0.008	0.005	0.003	0.000	-0.003	-0.005
	40	104	0.024	0.022	0.019	0.016	0.014	0.011	0.008	0.005	0.003	0.000	-0.003
50	122	0.027	0.024	0.022	0.019	0.016	0.014	0.011	0.008	0.005	0.003	0.000	

TABLE 2 - METRIC

		AVERAGE TEMPERATURE AT TIME OF CUTTING & INSTALLATION											
°C		-50	-40	-30	-20	-10	0	10	20	30	40	50	
°F		-58	-40	-22	-4	14	32	50	68	86	104	122	
MIN/MAX POST CONSTRUCTION TEMP.	°C	°F	EXPANSION OR CONTRACTION (MM/METER)										
	-50	-58	0.000	-0.230	-0.460	-0.690	-0.920	-1.150	-1.380	-1.610	-1.840	-2.070	-2.300
	-40	-40	0.230	0.000	-0.230	-0.460	-0.690	-0.920	-1.150	-1.380	-1.610	-1.840	-2.070
	-30	-22	0.460	0.230	0.000	-0.230	-0.460	-0.690	-0.920	-1.150	-1.380	-1.610	-1.840
	-20	-4	0.690	0.460	0.230	0.000	-0.230	-0.460	-0.690	-0.920	-1.150	-1.380	-1.610
	-10	14	0.920	0.690	0.460	0.230	0.000	-0.230	-0.460	-0.690	-0.920	-1.150	-1.380
	0	32	1.150	0.920	0.690	0.460	0.230	0.000	-0.230	-0.460	-0.690	-0.920	-1.150
	10	50	1.380	1.150	0.920	0.690	0.460	0.230	0.000	-0.230	-0.460	-0.690	-0.920
	20	68	1.610	1.380	1.150	0.920	0.690	0.460	0.230	0.000	-0.230	-0.460	-0.690
	30	86	1.840	1.610	1.380	1.150	0.920	0.690	0.460	0.230	0.000	-0.230	-0.460
	40	104	2.070	1.840	1.610	1.380	1.150	0.920	0.690	0.460	0.230	0.000	-0.230
50	122	2.300	2.070	1.840	1.610	1.380	1.150	0.920	0.690	0.460	0.230	0.000	

1.5. Surface Finish

The Longboard Link & Lock Privacy Screen system is available in a range of Woodgrain, Solid & Specialty Finishes with custom* solid colors available upon request. **Additional lead times apply.*

Longboard Woodgrains have a repeat pattern, shipped in sets. Install these as they come out of the box, as an A&B pattern staggering each set approx. 1-2' (305-610mm) from the previous set to achieve a random pattern aesthetic.

All Longboard Products are produced 1" (25mm) oversized, as one end is hole-punched (all finishes) and both ends have 1/2" (12mm) of masking tape (woodgrains only) which must be cut off for best results.



1.6. Material Ordering & Delivery

Link & Lock Privacy Screen is sold by the set (pair), end caps are sold by the box: 20 caps/bx. Lead time is 3-4 weeks* (**subject to change*), delivered on 24' (7.3m) long skids weighing up to 2000 lbs. A mechanical lift with forks is required on site to receive the order.

⚠ Always inspect the delivery for damage and contact LB ASAP if there are any issues: info@longboardproducts.com or 1-800-604-0343 and include your PO# and any pictures if possible. Mark the delivery receipt as "damaged" and accept the delivery as-is. Longboard is not responsible for the installation of blemished or damaged material.

1.7. Storage & Handling

Be sure to store the material flat, keep it dry, safe & secure and remain in unopened cartons until ready to be installed. Ensure proper care when handling, to avoid damage on site.

2.0. FRAMING REQUIREMENTS

2.1. General

Always consult the local building authority and follow local building code requirements.

2.2. Load Capacity

The Longboard Link & Lock Privacy Screen system weighs approx. 1.3 up to 1.9 lbs/LF*.

**see profile drawings for individual item weights.*

2.3.1. Wood-Framing

Traditional stud wall framed at 16" (406mm) o.c. with or without solid secure blocking running perpendicular to the Link & Lock Privacy Screen orientation (for vertical Privacy Screen applications), exterior wall sheathing, weather resistive barrier (wrb), wall finish or UV barrier. If furring strips are used, it is recommended to install at 16" (406mm) o.c. for material support and fasten at 5'4" (1.63m) o.c.

2.3.2. Metal Framing

16ga. (minimum) galvanized steel framing at 16" (406mm) O.C., exterior wall sheathing, wrb, wall finish or UV barrier. If furring strips are used, it is recommended to install at 16" (406mm) o.c. for material support and fasten at 5'4" (1.63m) o.c.

2.3.3. CMU/Concrete

Wrb, wood or metal furring strips (see 2.3.1. and 2.3.2. for standard requirements).

2.3.4. Posts & Other Structures

Solid, secure structure of material designed to support loading (see 2.2.), spaced at 6' (1.83m) o.c. max.

2.4. Framing Layout

Provide solid secure framing and/or blocking at 16" (406mm) o.c. for material support and fasten at 5'4" (1.63m) o.c.

3.0. SYSTEM INSTALLATION

3.1. Layout

Measure and layout your privacy area to consider alignment with fixtures, openings and adjacent walls, for desired appearance.

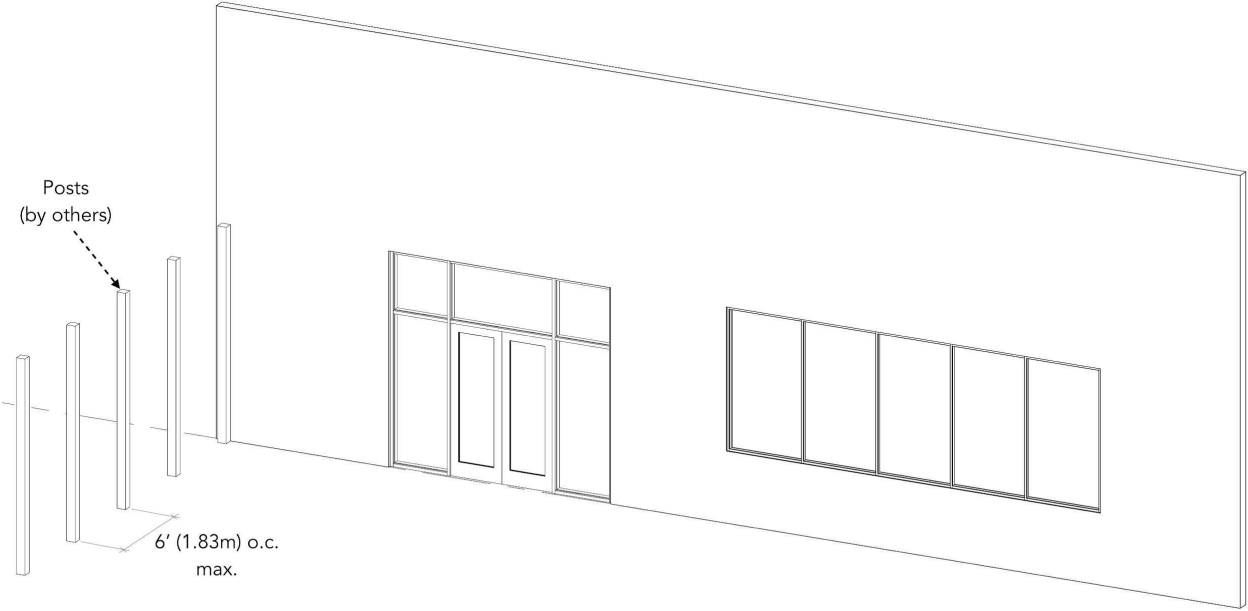

3.2. Installation

Privacy Battens and Fins should be installed with staggered butt-joints in applications with longer lengths, leaving a 1/4" (6mm)(minimum) gap between each member to allow for expansion & contraction. See 1.4.1.Expansion & Contraction.

3.2.①. BACK "L"

Install the back "L" (see 1.4. Fastening). Install end caps (see: 3.3.③.) where access will be restricted upon installation.

TIP! It is good practice to check your installation every 2-3 rows for alignment and flat/straight, for best results.

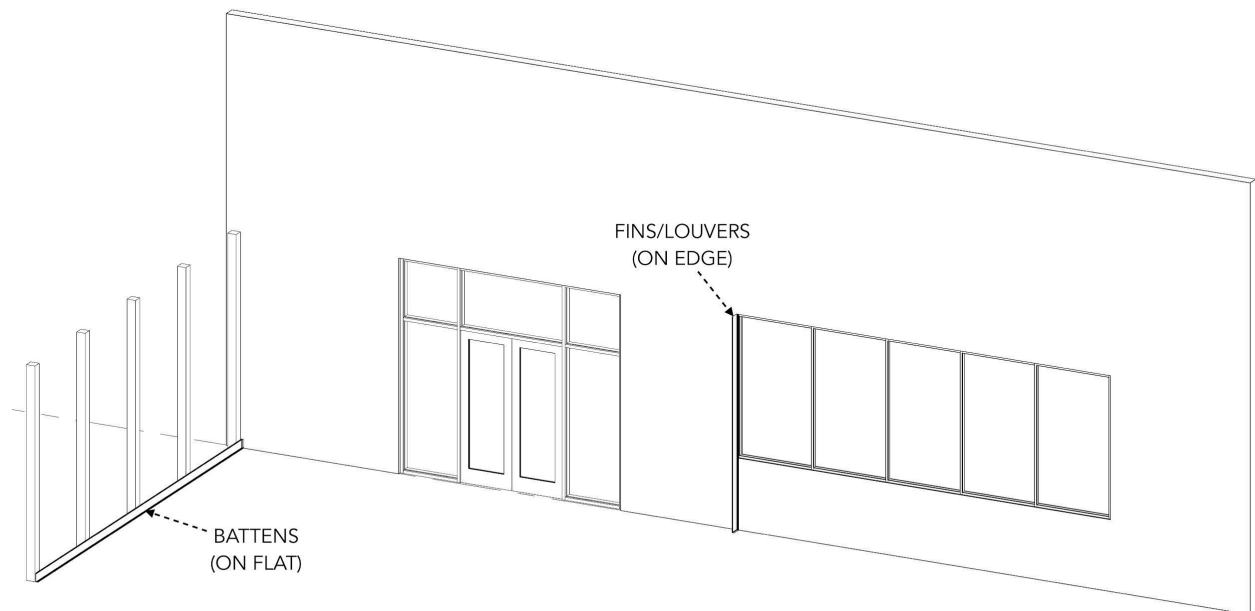

3.2.②. FRONT "L"

Install the front "L" onto the base "L" (see 1.4.1. Expansion & Contraction) using a rubber mallet/hammer & block to protect the finish. Consider your application sequence of end caps before installing adjacent Link & Lock members, as they may limit the space needed to insert caps. All pieces are friction fit: If preferred, place a single small pea-sized spot of a structural grade silicone (not included) inside the connecting surface to prevent slippage (front "L") or ease of removal (end caps).

Repeat steps 1 & 2 until installation is complete.

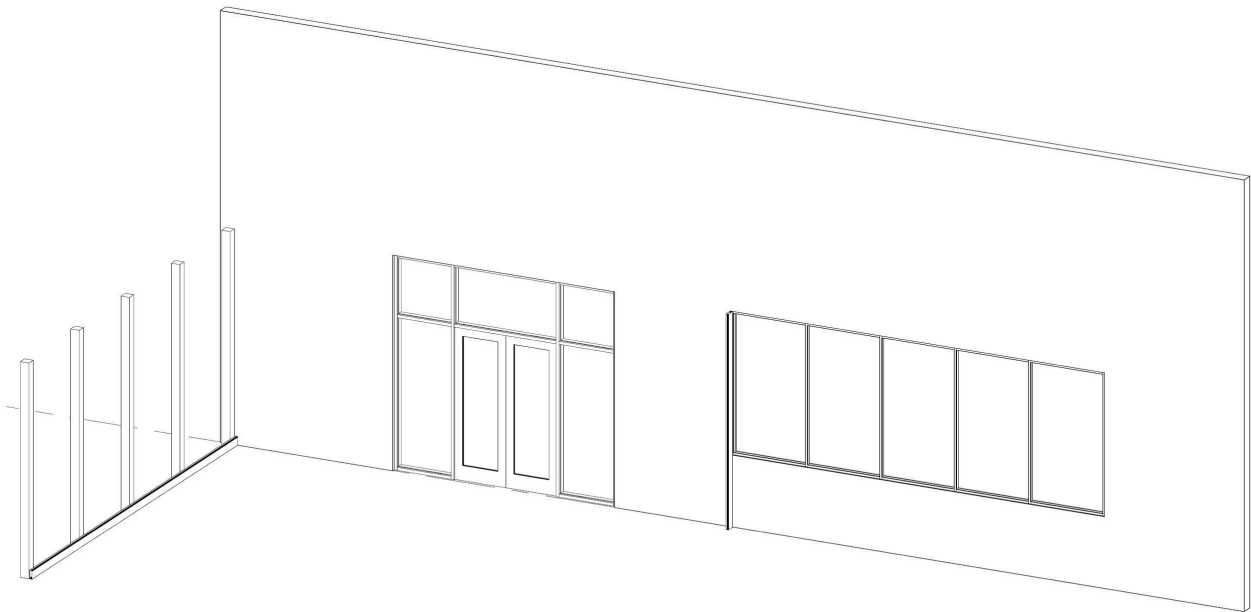

3.2.③. END CAPS

Upon completion of installed area(s), install any and all end caps at open ends (see: 3.3.③.).

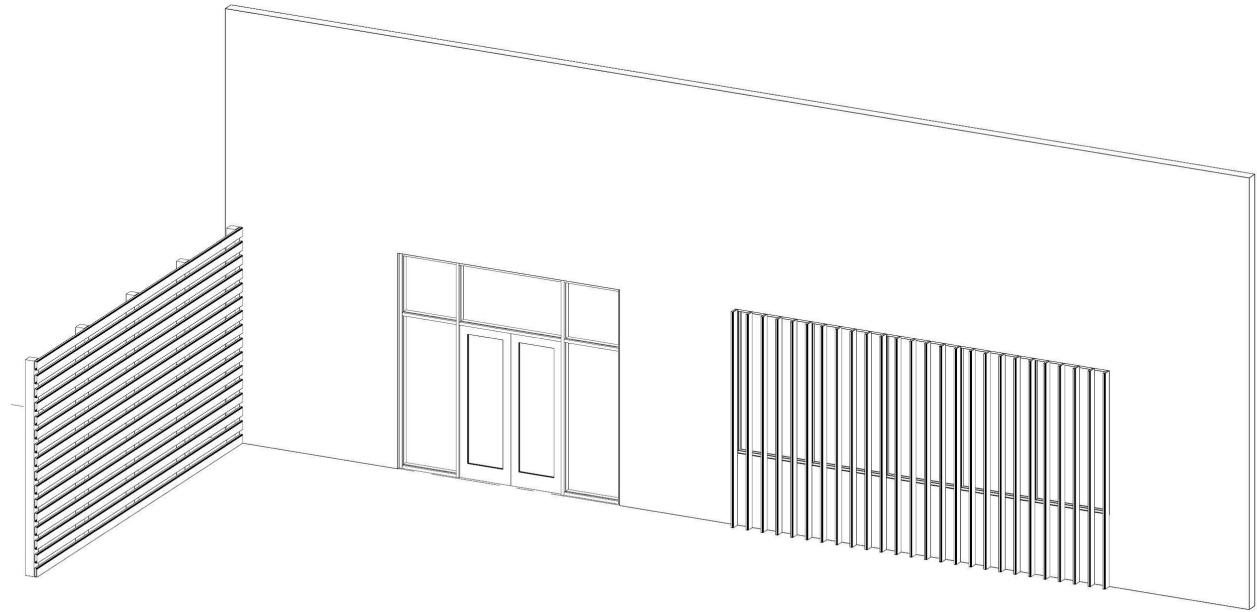

3.3.③. END CAPS



4.0. Cleaning Recommendations

**see Cleaning Guide for full requirements*

longboardproducts.com

While Longboard finishes require zero maintenance, we do recommend periodic cleaning to keep the product looking its best. Our finish is tested to withstand corrosion, fading and normal wear, however, neglect and rough conditions could have negative effects on the surface finish. These effects will not negate the structural performance of the product, but prolonged exposure to these conditions may result in permanent markings or surface damage.

Cleaning should be done in mild weather, and never in direct sunlight. Always complete a test patch on an inconspicuous area to ensure your detergent is suitable for the surface.

Your Longboard products should be cleaned immediately after installation. This is to remove any construction soils such as oils or dust. How to complete this initial cleaning depends on the level of dirt and the nature of the soil. See the cleaning guide for our suggestions based on soil level. Basic methods use a combination of moderate water pressure, soft sponge/brush and a mild detergent.

 NEVER use aggressive acid or alkaline cleaners on Longboard finishes. Do not use cleaners containing Trisodium Phosphate, Phosphoric Acid, Hydrochloric Acid, Hydrofluoric Acid, Fluorides or any other compound that is known to react with metal.

Always follow the product instructions for dilution. Cleaning the surface with a cleanser that is not diluted may result in damage to the coating.













5.0. WARRANTY

Upon substantial completion of the project, register for warranty online here:

longboardproducts.com/warranty

 Registration is required for the warranty to be in effect.

APPENDIX

INSTRUCTION STEP #	IMAGE	DESCRIPTION	TYPICAL USE	SECTION DETAIL (scan or click)
① ②		4" LINK & LOCK, 24' (7.3m) LENGTHS, WOODGRAIN, SOLID, SPECIALTY, CUSTOM SOLID	HORIZONTAL OR VERTICAL BATTEN/FIN/LOUVER	
① ②		6" LINK & LOCK, 24' (7.3m) LENGTHS, WOODGRAIN, SOLID, SPECIALTY, CUSTOM SOLID	HORIZONTAL OR VERTICAL BATTEN/FIN/LOUVER	
① ②		8" LINK & LOCK, 24' (7.3m) LENGTHS, WOODGRAIN, SOLID, SPECIALTY, CUSTOM SOLID	HORIZONTAL OR VERTICAL BATTEN/FIN/LOUVER	
③		4" END CAP, WOODGRAIN, SOLID, SPECIALTY, CUSTOM SOLID	FINISHED CAP AT ENDS OF EACH BATTEN/FIN/LOUVER	
③		6" END CAP, WOODGRAIN, SOLID, SPECIALTY, CUSTOM SOLID	FINISHED CAP AT ENDS OF EACH BATTEN/FIN/LOUVER	
③		8" END CAP, WOODGRAIN, SOLID, SPECIALTY, CUSTOM SOLID	FINISHED CAP AT ENDS OF EACH BATTEN/FIN/LOUVER	

Tongue & Groove Planks

V-Groove Planks

Size	12' *	24' *	12' Perf *	24' Perf *
2 1/4"	3V.145	3V.289	3VP.145	3VP.289
4"	4V.145	4V.289	-	-
6"	6V.145	6V.289	6VP.145	6VP.289

Smooth Planks

Size	12' *	24' *	12' Perf *	24' Perf *
6"	6PSP.145	6PSP.289	6PSP.145	6PSP.289

Channel Planks

Size	12' *	24' *
6"	6CH.145	6CH.289

Accessories

Product	Qty	SKU
Quick Screen Clips	1750, box	CLIP.N1750
Quick Screen Clips	100, bag	CLIP.N100
Touch Up Pens <i>Reach out to confirm color with account manager.</i>	N/A	TUP

Component Trims

Type	Style	Product	Dimensions	SKU
Starter	Precision	Starter J-Track	(5/8") - 12'	1SJT.145
Starter	Traditional	Starter Strip	(1-7/8") - 12'	2SS.145
Starter	Traditional	Back-to-Back Starter Strip	(1-1/4")	2BTSS.145
J-Track	Precision	Two Piece J-Track	(5/8") - 12'	1X1JT.145
J-Track	Precision	J-Track	(5/8") - 12'	1JT.145
J-Track	Craftsman	Two Piece J-Track	(7/8") - 12'	JT23S.145
J-Track	Traditional	Two Piece J-Track	(1-3/8") - 12'	1X2JT.145
Corner	Precision	Outside Corner	(3/16") - 12'	05OC.145
Corner	Craftsman	Inside Corner	(3/4") - 12'	1IC.145
Corner	Craftsman	Outside Corner	(1") - 12'	1OC.145
Corner	Traditional	Corner Set	(2") - 12'	2CORS.145
Reveal	Precision	Flat Reveal	(1/2") - 12'	1FR.145
Reveal	Precision	T&G Flat Reveal	(1/2") - 24'	1TGFR.289
Reveal	Craftsman	U-Reveal Set	(3/4") - 12'	1URS.145
Reveal	Craftsman	T&G U-Reveal	(3/4") - 24'	1TGURK.289
Reveal	Traditional	U-Reveal Set	(1-1/2") - 12'	2URS.145
Reveal	Traditional	Flat Reveal Set	(1-1/2") - 12'	2FRS.145
Reveal	Traditional	T&G U-Reveal	(1 1/2") - 24'	2TGURK.289
Reveal	Traditional	Offset Flat Reveal Set, J-Track Base	(2") - 12'	2OFFJ.145
Reveal	Traditional	Offset Flat Reveal Set, Termination Base	(2") - 12'	2OFFT.145
Termination	Precision	Termination Set	(5/8") - 12'	1TS.145
Termination	Craftsman	Termination Set	(7/8") - 12'	TS.145
Termination	Traditional	Termination Set	(1-3/8") - 12'	2TS.145
Compression Joints	Traditional	Compression Joint	(1-3/8") - 24'	2CJ.289



V-Groove Planks



Channel Planks



Smooth Planks



Perforated Planks



Precision Starter J-Track



Traditional Starter Strip



Traditional Back-to-Back Starter Strip



Precision Two-Piece J-Track



Precision J-Track



Traditional Two Piece J-Track



Traditional Two Piece J-Track



Precision Outside Corner

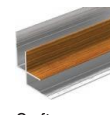

Craftsman Inside Corner

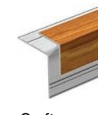

Craftsman Outside Corner

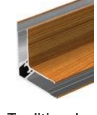

Traditional Corner Set

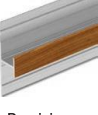

Precision Flat Reveal



Precision T&G Flat Reveal



Craftsman U-Reveal Set



Craftsman T&G U-Reveal



Traditional U-Reveal Set



Traditional Flat Reveal Set



Traditional T&G U-Reveal



Traditional Offset Flat Reveal Set, J-Track Base



Traditional Offset Flat Reveal Set, Termination Base



Precision Termination Set



Craftsman Termination Set



Traditional Termination Set

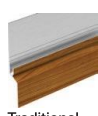

Traditional Compression Joint

* 48 sq. ft. box quantities † 96 sq. ft. box quantities

Link & Lock™ Battens

Size	12'	24'	End Caps (20/box)	End Mounts (20/box)
2"	2X2LL.145	2X2LL.289	2LLEC.2	2LLEM.2
4"	2X4LL.145	2X4LL.289	2LLEC.4	2LLEM.4
6"	2X6LL.145	2X6LL.289	2LLEC.6	2LLEM.6
8"	2X8LL.145	2X8LL.289	2LLEC.8	2LLEM.8

Mounting Accessories	Qty	SKU
Link & Lock Mounting Clip	48, bag	LLMC.N48
Dewalt® 1/2" Pilot Point Drill Bit	1	DRILLBT.05
24" Link & Lock Internal Stiffener	1	LLSTIFF.289
3M® Double Sided Adhesive Tape - 108'	1, roll	LLTAPE.1296



Link & Lock™
Batten

Privacy Screen System

Size	Product	24'	End Caps (20/box)
1x3"	Privacy Beam	1X3B.289	1BEC.3
1x5"	Privacy Beam	1X5B.289	1BEC.5
2x2"	Privacy Post	2X2SP.289	2X2PC.2
1x3"	Privacy Post	2X3DP.289	2X3PC.3

Mounting Accessories	Qty	SKU
1x3" & 1x5" Spacer Block	100, box	2X2SB.N100
1x3" & 1x5" Spacer Bar	1	1X2FB.145
1x3" Spacer Bar	100, box	1X2FB.1
1x5" Spacer Bar	100, box	1X2FB.3
3" Privacy Screen Mounting Bracket	100, box	3PSMB.1
#10 Black Screws	100, box	PECS.N100



Privacy Beam

Finishes

Woodgrain	15 Year Warranty	20 Year Warranty
Birchwood	15BWD	20BWD
Beechwood	15BEE	-
Blonde Oak	15BOK	-
Dark Acacia	15DAC	20DAC
Dark Antique Oak	15DOA	20DOA
Dark Bamboo	15DBB	20DBB
Dark Cherry	15DCY	20DCY
Dark Fir	15DFR	20DFR
Dark Knotty Pine	15DKP	20DKP
Dark National Walnut	15DNW	20DNW
Dark Walnut	15DWL	20DWL
Italian Rosewood	15IRW	20IRW
Light Bamboo	15LBB	20LBB
Light Cherry	15LCY	20LCY
Light Fir	15LFR	20LFR
Light National Walnut	15LNW	20LNW
Light Oak	15LOK	20LOK
National Mahogany	15NMH	20NMH
Southern Yellow Pine	15SYP	-
Table Walnut	15TWL	20TWL
Western Cedar	15WCD	20WCD
White Oak	15WOK	20WOK

Solid Color	15 Year Warranty	20 Year Warranty
Black	15BLA	20BLA
Bone White	15BWH	20BWH
Brick Red	15BRD	20BRD
Charcoal	15CHA	20CHA
Chili Pepper	15CHP	20CHP
Classic Bronze	15CBZ	20CBZ
Dark Brown	15DBR	20DBR
Graphite	15GRA	20GRA
Medium Blue	15MBL	20MBL
Slate Grey	15SGR	20SGR
Ultra White	15UWH	20UWH

Specialty	15 Year Warranty	20 Year Warranty
Anodic Ice	15AIC	20AIC
Biscotti	15BIS	20BIS
Burnt Sienna	15BSN	20BSN
Canyon Vista	15CVI	20CVI
Ceramic Clay	15CCL	20CCL
Copper Penny	15CPE	20CPE
Moonstone	15MOO	20MOO
Old Navy	15ONA	20ONA
Platinum Ice	15PIC	20PIC
Venus	15VEN	20VEN

Naturally Aged Metals	15 Year Warranty
Carbon Mist	15CMI
Molten	15MOL
Smokey Topaz	15STO
Toasted Mocha	15TMO

Example of complete product SKU

6V.289.15DFR
(Product.Length.Finish)

Finish Options

We help you achieve your vision. Whether you're looking to create a space that offers the warmth of natural woodgrain or a modern industrialized aged metal, we have a finish option for you.

Require a custom finish or color? Our experienced color matching team can make it a reality.

Special order finishes may require additional production lead time or pricing.

- Interior Only
- Special Order
- High Gloss Finish
- Shimmer Finish
- Low Gloss Finish
- Terracota Finish

Woodgrains



Dark Cherry



Light Cherry



Dark Fir



Light Fir



Dark National Walnut



Light National Walnut



Dark Walnut



Table Walnut



Western Cedar



Italian Rosewood



Dark Acacia



Dark Antique Oak



Dark Bamboo



Light Bamboo



Dark Knotty Pine



Light Oak



National Mahogany



White Oak



Weathered Gray



Blonde Oak



Southern Yellow Pine



Beechwood

Solid Colors



Black



Bone White



Brick Red



Graphite

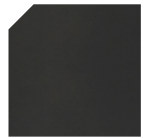

Charcoal

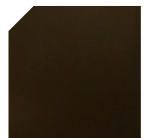

Classic Bronze



Medium Blue



Slate Gray



Chili Pepper



Ultra White



Ceramic Clay



Moonstone



Platinum Ice

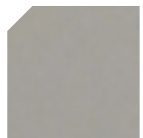

Anodic Ice

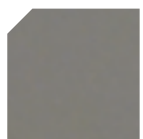

Venus



Old Navy

Naturally Aged Metals



Carbon Mist



Molten



Smokey Topaz



Toasted Mocha

Others



Biscotti



Canyon Vista

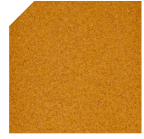

Burnt Sienna



Copper Penny

Warranty granted to (company name):

Longboard Architectural Products Inc. ("Longboard," "The Company") products as identified by the Product Codes listed will conform to the standards set out in Clause 1 and Clause 2 of this Warranty, subject to the terms and conditions set out in Clause 3 and 4 of this Warranty.

Product codes: Product description:

<input type="text"/>	<input type="text"/>
<input type="text"/>	<input type="text"/>
<input type="text"/>	<input type="text"/>
Finish:	<input type="text"/>

<input type="text"/>	
<input type="text"/>	
<input type="text"/>	
<input type="text"/>	<input type="text"/>
<input type="text"/>	

Clause 1

Extruded Aluminum Profile(s)

Longboard expressly warrants that its product line is free from manufacturing defects in material or workmanship.

- 1.1 When siding is applied according to Longboard instructions and properly maintained, such product is guaranteed against the following:
- 1.2 Buckling: The product itself will be free of any buckling that is not associated with the substrate and/or structure to which the Longboard system is attached. For the purpose of this warranty, buckling shall be defined as warping of the product(s) exceeding one sixteenth of an inch out of plane per linear foot.
- 1.3 Corrosion: When applied according to Longboard instructions and properly maintained, such product is further guaranteed against rusting and corroding. Subject to the limitations set out in Clause 3 and 4.
- 1.4 What we will do: If, during the fifteenth (15th) year Limited Warranty Period on the powder coating finish, the Product is defective in material or workmanship, Longboard will, in its sole discretion, either repair or replace the defective portion of the Product.
- 1.5 What we will do: If, during the 50-year Limited Warranty Period on the aluminum extruded profiles, the Product is defective in material or workmanship, Longboard will, in its sole discretion, either repair or replace the defective portion of the Product.
- 1.6 After the 15th year, this Limited Warranty on the powder coated finish will expire and shall no longer be applicable.
- 1.7 After the 50th year, this Limited Warranty on the aluminum extruded profile(s) will expire and shall no longer be applicable.
- 1.8 Longboard replacement of the defective Product or reimbursement of this Limited Warranty is the exclusive remedy for the Covered Person for any defect in materials or workmanship. The Company will not refund or pay any costs in connection with labor or accessory materials.

Clause 2

- 2.1 During the first fifteen (15) years of this warranty:
- 2.2 Checking/Cracking: No visible checking or cracking of the product finish on the building.
- 2.3 Chalking Resistance: No chalking of the product finish on the building in excess of that represented by No.6 rating based on ASTM D4214.
- 2.4 Color Retention: No color change of the product finish on the building greater than 5 (five) CIE Lab ΔE units calculated in accordance with ASTM 2244 Section 6.3. Color change shall be measured on the exposed paint surface which has been cleaned of oil, grease, chalk, oxidized film or other contaminants, corresponding values shall be measured on the control panel.
- 2.5 Gloss Retention: Coated surface will exhibit gloss retention

of a minimum of 30% of the original. Gloss retention shall be measured on the exposed paint surface which has been cleaned of oil, grease, chalk, oxidized film or other contaminants, corresponding values shall be measured on the control panel.

- 2.6 Adhesion: Adhesion of product finish when initially applied to test panels and measured by reference to AAMA 2604-02 Clause 7.4.2 will show no removal of the film.

Clause 3

- 3.1 Warranty Terms and Conditions:
- 3.2 The "Warranty Period" for the warranties in Clause 1 shall mean fifty (50) years or for as long as the original "owner" and/or "purchaser" named above shall live and own the property on which the material was originally installed.
- 3.3 Clause 3: Shall mean fifteen (15) years, commencing on the date of completion.
- 3.4 Registration of the product is required for the warranty to be in effect. This warranty is valid for the original purchaser and one other owner of the structure where the product(s) have been installed.
- 3.7 Normal atmospheric conditions exclude corrosive or aggressive atmospheres such as those contaminated with chemical fumes or other corrosive elements. The product finish is not meant for marine use on boats, ships or offshore platforms.

Clause 4

- 4.1 This warranty will not extend or cover:
- 4.2 Damages to the coated metal caused by handling, shipping, processing and/or installation; or
- 4.3 Damages to the coated metal caused by scratching or abrading after installation; or
- 4.4 Damages to the coated metal as a result of standing water in horizontal installations.
- 4.5 The warranty will not be applicable to damage or failure, which is caused by acts of God, falling objects, external forces, explosions, fire, riots, civil commotion's, acts of war, or other such similar or dissimilar occurrences beyond The Company's control.
- 4.6 Customer shall make available to The Company the dates of the installation of the coated metal, the maintenance records including details of washing and cleaning procedures in compliance with the annual cleaning requirements as stated in the Required Maintenance section of this warranty. Customers shall demonstrate that the failure of the coated metal was due to a breach of the warranty stated herein.
- 4.7 Claims must be made in writing to Longboard within 30 days of the discovery of a problem and authorization obtained prior to beginning any repair and/or refinishing work. The claimant must provide proof of coverage. Claims can be made by writing to Longboard at the Product Performance Department. After receiving such notice, The Company

must be given a reasonable opportunity to inspect and verify the claim.

- 4.8 Longboard exclusive liability under this warranty, or otherwise, will be limited to refinishing and/or repairing, at The Company's sole discretion, the defective powder coating. The warranty on any refinished, repaired or replaced coated metal supplied hereunder shall be for the remainder of the warranty period applicable to the originally coated metal. All warranty work will be performed by a company or contractor selected by Longboard. Color variance between refinished and/or repainted product and original shall not be indicative of a defect.
- 4.9 This warranty represents the entire agreement between parties in relation to its subject matter and supersedes any previous agreement whether written or oral between the parties in relation to its subject matter. The limited warranties state the entire liability of Longboard with respect to the products covered by them. The Company shall have no liability for any incidental or consequential damages. No person is authorized to make any representation or warranty on behalf of Longboard except as expressly set forth above, and any such statement shall not be binding on The Company. Except as expressly set forth above, Longboard makes no warranty of any kind, express or implied, including, without limitation, any implied warranty of merchantability or fitness for a particular purpose. Warranties shall be the duration of the limited warranty, or such shorter duration as provided under applicable local law. These limited warranties give you specific legal rights, and you may also have other rights which vary from area to area.
- 4.91 Nothing in this warranty shall be construed as a warranty of the workmanship of any installer or as imposing on Longboard any liability for unsatisfactory performance caused by faulty workmanship in installation.
- 4.92 It's agreed all parties involved that all claims and disputes relating to this agreement that cannot be settled through negotiation will try in good faith to first settle the dispute by mediation administered by the American Arbitration Association (Construction Industry Mediation Procedures) as a prelude to mandatory binding arbitration. Such binding arbitration is to be conducted and administered by the Construction Industry Arbitration Rules of the American Arbitration Association. Both seller and purchaser agree to share equally in the costs of both mediation and arbitration and that such binding arbitration will be the sole and final remedial action.
- 4.93 Required Maintenance. On an annual basis use a soft sponge or cloth, water and mild detergent, non-abrasive soap with the pH range of 5-9 to clean the powder coated area of dirt, grime and other debris. Pressure washing and the use of harsh detergents or chemicals is not recommended. Include in your maintenance records the following: date, time, specific products used, name of maintenance person and their designation, maintenance company name and general condition of the powder coated finish.

I have read and agree to the terms of the Longboard® Product 15 year powder coated surface and 50 year aluminum extruded profile(s) warranty and acknowledge receipt of a copy of the Warranty Certificate.

Name of owner or contractor:

Date:

Signature:



Duly authorized on behalf of Longboard:

Name and designation:

Date:

Signature:

Warranty granted to (company name):

Longboard Architectural Products Inc. ("Longboard," "The Company") products as identified by the Product Codes listed will conform to the standards set out in Clause 1 and Clause 2 of this Warranty, subject to the terms and conditions set out in Clause 3 and 4 of this Warranty.

Product codes: Product description:

<input type="text"/>	<input type="text"/>
<input type="text"/>	<input type="text"/>
<input type="text"/>	<input type="text"/>
Finish:	<input type="text"/>

<input type="text"/>	
<input type="text"/>	
<input type="text"/>	
<input type="text"/>	<input type="text"/>
<input type="text"/>	

Clause 1

Extruded Aluminum Profile(s)
Longboard expressly warrants that its product line is free from manufacturing defects in material or workmanship.

- 1.1 When siding is applied according to Longboard instructions and properly maintained, such product is guaranteed against the following:
- 1.2 Buckling: The product itself will be free of any buckling that is not associated with the substrate and/or structure to which the Longboard system is attached. For the purpose of this warranty, buckling shall be defined as warping of the product(s) exceeding one sixteenth of an inch out of plane per linear foot.
- 1.3 Corrosion: When applied according to Longboard instructions and properly maintained, such product is further guaranteed against rusting and corroding. Subject to the limitations set out in Clause 3 and 4.
- 1.4 What we will do: If, during the twenty (20) year Limited Warranty Period on the powder coating finish, the Product is defective in material or workmanship, Longboard will, in its sole discretion, either repair or replace the defective portion of the Product.
- 1.5 What we will do: If, during the 50-year Limited Warranty Period on the aluminum extruded profiles, the Product is defective in material or workmanship, Longboard will, in its sole discretion, either repair or replace the defective portion of the Product.
- 1.6 After the 20th year, this Limited Warranty on the powder coated finish will expire and shall no longer be applicable.
- 1.7 After the 50th year, this Limited Warranty on the aluminum extruded profile(s) will expire and shall no longer be applicable.
- 1.8 Longboard replacement of the defective Product or reimbursement of this Limited Warranty is the exclusive remedy for the Covered Person for any defect in materials or workmanship. The Company will not refund or pay any costs in connection with labor or accessory materials.

Clause 2

- 2.1 During the first twenty (20) years of this warranty:
- 2.2 Checking/Cracking: No visible checking or cracking of the product finish on the building.
- 2.3 Chalking Resistance: No chalking of the product finish on the building in excess of that represented by No.8 rating based on ASTM D4214.
- 2.4 Color Retention: No color change of the product finish on the building greater than 5 (five) CIE Lab ΔE units calculated in accordance with ASTM 2244 Section 6.3. Color change shall be measured on the exposed paint surface which has been cleaned of oil, grease, chalk, oxidized film or other contaminants, corresponding values shall be measured on the control panel.
- 2.5 Gloss Retention: Coated surface will exhibit gloss retention

of a minimum of 30% of the original. Gloss retention shall be measured on the exposed paint surface which has been cleaned of oil, grease, chalk, oxidized film or other contaminants, corresponding values shall be measured on the control panel.

- 2.6 Adhesion: Adhesion of product finish when initially applied to test panels and measured by reference to AAMA 2604-02 Clause 7.4.2 will show no removal of the film.

Clause 3

- 3.1 Warranty Terms and Conditions:
- 3.2 The "Warranty Period" for the warranties in Clause 1 shall mean fifty (50) years or for as long as the original "owner" and/or "purchaser" named above shall live and own the property on which the material was originally installed.
- 3.3 Clause 3: Shall mean twenty (20) years, commencing on the date of completion.
- 3.4 Registration of the product is required for the warranty to be in effect. This warranty is valid for the original purchaser and one other owner of the structure where the product(s) have been installed.
- 3.7 Normal atmospheric conditions exclude corrosive or aggressive atmospheres such as those contaminated with chemical fumes or other corrosive elements. The Aluminate Ultra finish is not meant for marine use on boats, ships or offshore platforms.

Clause 4

- 4.1 This warranty will not extend or cover:
- 4.2 Damages to the coated metal caused by handling, shipping, processing and/or installation; or
- 4.3 Damages to the coated metal caused by scratching or abrading after installation; or
- 4.4 Damages to the coated metal as a result of standing water in horizontal installations.
- 4.5 The warranty will not be applicable to damage or failure, which is caused by acts of God, falling objects, external forces, explosions, fire, riots, civil commotion's, acts of war, or other such similar or dissimilar occurrences beyond The Company's control.
- 4.6 Customer shall make available to The Company the dates of the installation of the coated metal, the maintenance records including details of washing and cleaning procedures in compliance with the annual cleaning requirements as stated in the Required Maintenance section of this warranty. Customers shall demonstrate that the failure of the coated metal was due to a breach of the warranty stated herein.
- 4.7 Claims must be made in writing to Longboard within 30 days of the discovery of a problem and authorization obtained prior to beginning any repair and/or refinishing work. The claimant must provide proof of coverage. Claims can be made by writing to Longboard at the Product Performance Department. After receiving such notice, The Company

must be given a reasonable opportunity to inspect and verify the claim.

- 4.8 Longboard exclusive liability under this warranty, or otherwise, will be limited to refinishing and/or repairing, at The Company's sole discretion, the defective powder coating. The warranty on any refinished, repaired or replaced coated metal supplied hereunder shall be for the remainder of the warranty period applicable to the originally coated metal. All warranty work will be performed by a company or contractor selected by Longboard. Color variance between refinished and/or repainted product and original shall not be indicative of a defect.
- 4.9 This warranty represents the entire agreement between parties in relation to its subject matter and supersedes any previous agreement whether written or oral between the parties in relation to its subject matter. The limited warranties state the entire liability of Longboard with respect to the products covered by them. The Company shall have no liability for any incidental or consequential damages. No person is authorized to make any representation or warranty on behalf of Longboard except as expressly set forth above, and any such statement shall not be binding on The Company. Except as expressly set forth above, Longboard makes no warranty of any kind, express or implied, including, without limitation, any implied warranty of merchantability or fitness for a particular purpose. Warranties shall be the duration of the limited warranty, or such shorter duration as provided under applicable local law. These limited warranties give you specific legal rights, and you may also have other rights which vary from area to area.
- 4.91 Nothing in this warranty shall be construed as a warranty of the workmanship of any installer or as imposing on Longboard any liability for unsatisfactory performance caused by faulty workmanship in installation.
- 4.92 It's agreed all parties involved that all claims and disputes relating to this agreement that cannot be settled through negotiation will try in good faith to first settle the dispute by mediation administered by the American Arbitration Association (Construction Industry Mediation Procedures) as a prelude to mandatory binding arbitration. Such binding arbitration is to be conducted and administered by the Construction Industry Arbitration Rules of the American Arbitration Association. Both seller and purchaser agree to share equally in the costs of both mediation and arbitration and that such binding arbitration will be the sole and final remedial action.
- 4.93 Required Maintenance. On an annual basis use a soft sponge or cloth, water and mild detergent, non-abrasive soap with the pH range of 5-9 to clean the powder coated area of dirt, grime and other debris. Pressure washing and the use of harsh detergents or chemicals is not recommended. Include in your maintenance records the following: date, time, specific products used, name of maintenance person and their designation, maintenance company name and general condition of the powder coated finish.

I have read and agree to the terms of the Longboard® Product 20 year powder coated surface and 50 year aluminum extruded profile(s) warranty and acknowledge receipt of a copy of the Warranty Certificate.

Name of owner or contractor:

Date:

Signature:



Duly authorized on behalf of Longboard:

Name and designation:

Date:

Signature: